



REDÜKTÖR VARYATÖR SAN. ve TİC. A.Ş. / GEARBOX & VARIATOR CORPORATION



IRC - SERIES

OPERATING GUIDE

EN

1 – Important Notes	1
1.1– <i>General</i>	1
1.2 - <i>Explanatipns</i>	2
2 – Security Notes	3
3 – Hauling and Storage	6
3.1 – <i>Hauling</i>	6
3.2 – <i>Storage</i>	6
4 – Mounting and Dismounting	8
5 – Operation	11
6 – Control and Maintenance	12
6.1 – <i>Control and Maintenance (Gearboxes)</i>	12
6.2 - <i>Control and Maintenance (Variators)</i>	12
7 – Frequently Asked Questions	13
8 – Lubricant Selections Table	14
9 – Mounting Positions	15
10 – General Parts List	16

1. IMPORTANT NOTES

1.1 GENERAL

This operating guide book covers the important rules concerning the hauling, installation and operation of gearbox.

These rules should be applied to guarantee an optimal performance of the gearbox and its longevity in time. Carefully read the information and apply it rigorously.

This operating manual should be kept along with other relevant documentation. This manual have to be stored by personnel appointed to that task. This document should always be available and kept in good conditions. In case of damage or lost of this manual, request a new version from I-MAK reseller or directly at the manufacturer.

Note that the manual for electrical motor coupled to the gearbox must be provided by the motor manufacturer.

The manufacturer reserve the only and exclusive right to add modification to this user manual, all modification made without confirmation of I-MAK will not be running and the manufacturer will not be held as responsible In case of damage or accidents.

Our company must be contacted with about the problems and applications concerning the issues that are not stated in this operating guide, and written information should be asked about solutions. Our company will not be held responsible on the contrary. Please contact with the following addresses and phone numbers in such situations.

İ-MAK REDÜKTÖR VARIYATÖR SANAYİ VE TİCARET A.Ş.

Sanayi cad. No:1 Şeyhli-Pendik –İstanbul-TURKEY





Tel: +90 216 378 26 36

Fax: +902163780686

e-mail: imak@imakreduktor.com





export@imakreduktor.com

web: www.imakreduktor.com

-  Before the beginning of all operations, please check that the gearbox is adapted for your application and that all technical data are matching with the offer confirmed by the manufacturer.
-  The gearbox that you have purchased have been designed to operate solely and they should never be coupled with other gearboxes or drive solutions without the acceptance of the manufacturer.
-  The gearbox that you have purchased have been manufactured according to the provisions numbered 98/37/AT (98/37/EEC) and in this scope, the manufacturer is responsible only if all the conditions stated in this manual are strictly applied.
-  The machines, that are to be coupled with the gearbox that you have purchased, must fulfil the basic requirements of the provisions numbered 98/37/ AT (98/37/EEC).

1.2 EXPLANATIONS

The description of the symbols in this operating guide is as follows:

-  This symbol calls attention to security measures that should be taken in order to prevent danger that may come to the unit you purchased.
-  This symbol calls attention to the security measures that would prevent personal injuries.
-  This symbol expresses possible dangers that may cause death and injuries.
-  This symbol expresses the rules that must be applied in any case.
-  This symbol represents to could harm the environment refers to rules that must be followed.



2. SECURITY NOTES

The gearboxes provided by I-MAK are designed and produced following strict and specific norms. Never attend to make modification to any parts of the gearbox without the authorization of the manufacturer. Any modification made on the gearbox will automatically result to the end of the guarantee period and a transmission of responsibilities from the manufacturer to your organization.



This product should only be used and operated under the conditions stated in the catalogue and operating guide.



All the person operating this gearbox should consult this Manual. The responsible person should also assure that they follow all the listed rules to ensure.

-
- The prevention of risks and danger that might cause injuries on the user and third parties.
- The safety and performance of the product.
- The prevention of pollution and environmental risks.
- Safety of the working environment.



The maintenance and the operation of this product can be made only by authorized and specialized personnel who has been trained to the requirements of the product.



The entire work shall be carried out carefully and with safety.



The operating guide that is given together with the gearbox should be protected with labels and warnings placed on the product from materials such as paint, dust, moisture etc. and should be renewed when necessary.



All maintenance and installation work to be carried out on the product (installation, hauling, mounting, maintenance etc.) should only be conducted when the product is completely stopped and the power is down. All safety precautions should be taken in order to prevent the accidental operation of the product. Signs and warnings that would prevent the product to operate, should be placed on the visible parts of the mechanism, which is coupled with the product, and on the start button in order to indicate that these processes continue on the product.



All rules concerning industrial safety and pollution control should be taken into consideration during usage, installation, operation, maintenance and protection.



The plant or application manager should assure that all the rotating part are covered to prevent all accidental contacts incurring a risk of crushing, cutting or entanglement. (All the basic requirements of the provision numbered 98/37/ AT (98/37/EEC) regarding safety precautions should be applied).



The gearbox should be immediately stopped in the case the unit produce excessive noise or face oil licking. Contact the manufacturer or the authorized reseller in your area



Remember that the oils used can be harmful to health and environment. All measure to prevent the contact of this oil with skin and eyes should be applied.



Old and dirty oil, drained from the product during the oil renewal, should be put into an appropriate container and destroyed in a proper process following your local rules regarding environmental protection. The extremely dirty and greasy cleaning elements should also be kept in appropriate containers and destroyed without harming the environment.



In the case the gearbox is used In a food processing environment, please inform the manufacturer to adapt the device to your activities. Direct contact with the food processed should also be avoided. The oils and lubricants should be adapted to your norms and hygiene requirements.

3. HAULING AND STORAGE

3.1. HAULING



The personnel operating the transport of the package should take all the necessary measures to protect their own safety and that of other people involved.

At the reception of the gearbox, make sure that the delivery corresponds to the gearbox you order and that the unit is not damaged. In case of problem report directly to the manufacturer or to the authorized reseller in your region.

During the lifting all the accessories such as screw clamps, eyebots, snap hooks, ropes and hooks should be certified and adequate for the load. Before handling please check the weight specified on the name plate or the catalogue. During transportation the product should be fixed upon the transportation vehicle to prevent all moves and risks of overturn.

3.2 STORAGE



The gearbox should be placed on a stable base and in a position avoiding all risk of it moving or falling out.



If the gearbox should be stored for a period superior to 4 months. Special precaution should be taken, it is necessary to keep the gearbox in a non-humid environment in which ambient temperature is not facing extreme variations. The gearbox should also be protected from dust and vibration. Protective oils that prevent the pivot ends from oxidation should be changed periodically.



Never change the covering of the gearbox. The mechanical (scratches), chemical (acid, alkaline melting) or thermal (spark, solder light, heat) damages that may possibly form on the covering may lead to rusting and outer protection deficiency.



If the gearbox is stored outside all precaution should be taken to assure that humidity or external materials don't affect the gearbox.



Periodically proceed to one or two turns of the output and input shaft, this action will avoid the damage of the bearing and the seals.



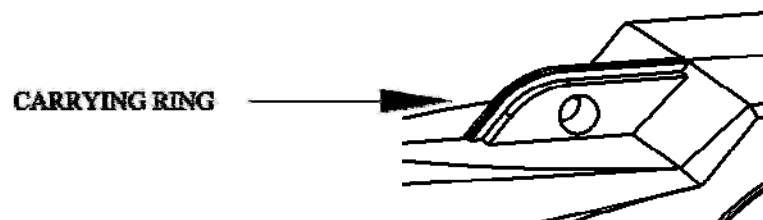
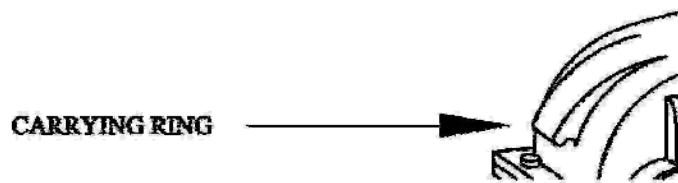
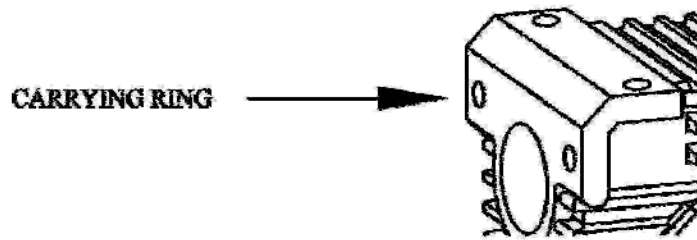
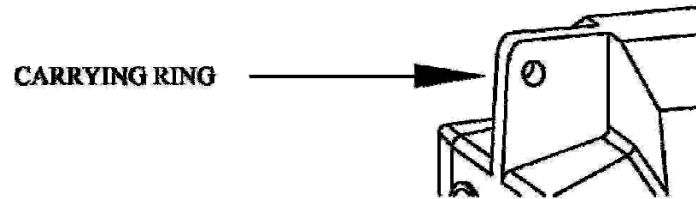
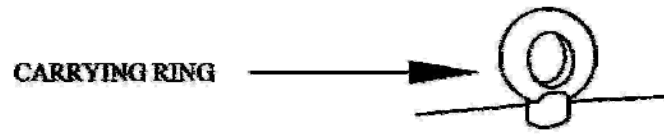

4. MOUNTING AND DISMOUNTING



The mounting process should be conducted by authorized personnel. The responsible personnel should take all the measure to avoid risks and dangers for the surrounding personnel.



The gearboxes should only be assembled and operated in assembling positions indicated in this operating manual. Manufacturer should be consulted before operating assembling positions not listed in this manual.



Before the mounting make sure to prepare a clean and clear area. All the requirements of the legislation number 98/37/ AT concerning this subject should be applied.



After mounting your gearbox on your application, operate a sound measurement to check the conformity of the sound level with the local legal legislations. The adequate volume depend on the speed, the power rate and the power proportion of the used unit.

- I. Before beginning the process of the assembling or disassembling of your gearbox read carefully all the sections of this manual.
- II. Carefully take care of removing all packaging and protective products on the gearbox. Make sure that you use suitable solvents. Avoid to apply any solvents on the shaft seal ring
- III. Before starting the mounting of the gearbox, make sure that the position of the vent plug is adapted to the assembling position. In case of any problems contact the manufacturer or the authorized seller in your region. *(Please check our catalogue to consult the different mounting position of the vent plug.*
- IV. In the case the gearbox is to be mount in outdoor environment, make sure that all the mounting and coupling material are protected against corrosions and external aggressions. Ensure that the gearbox is protect from dust, water and chemicals.
- V. Avoid the usage of hammers and any tools that might damage the gearboxes shafts, bearings or couplings. Follow the instruction and recommendations shown as below.

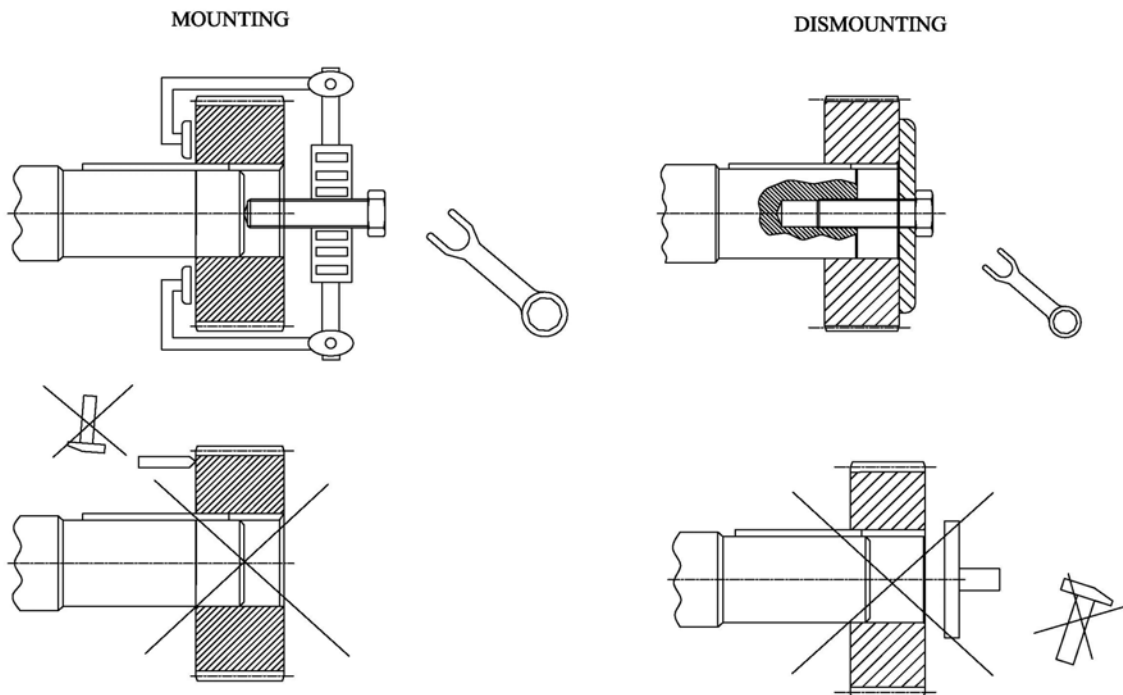

- VI. Avoid the usage of hammers and any tools that might damage the gearboxes shafts, bearings or couplings. Follow the instruction and recommendations shown as below.
- VII. The chassis on which you will mount your gearbox should be straight, clean and rigid.

VIII. If a coupling is going to be used;

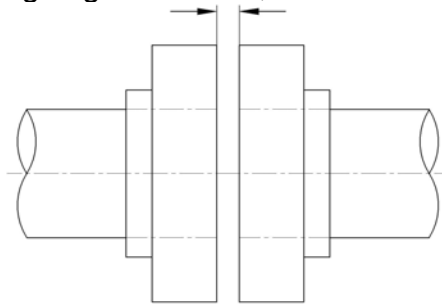

Ensure that there is enough space between the two couplings,

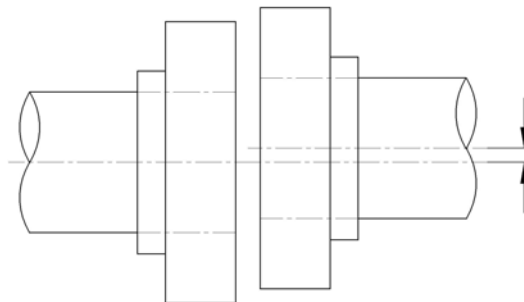

Make sure that the output shaft and the cylindrical shaft of the application are on the same axis,

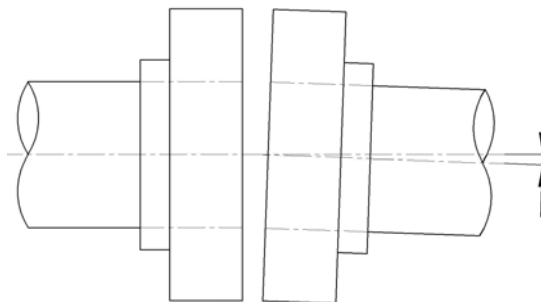

Always choose elastic couplings to reduce the load and rigidity.

5. OPERATION

- Fulfilling the requirement as listed in the operating guide, you can demonstrate the operation conditions of your gearbox and start operation of the product.
- For motor-driven type products check if grounding has been applied.
- For motor-driven type products be sure that the electrical connections are done correctly and firmly according to the electrical diagram on the Clemens box.
- Gearboxes may rotate in both ways except for the locked types. Before starting your machine ensure that the gearbox is mounted in the right direction. In the case your gearbox is equipped with a backstop device, you should avoid in any case the motors to turn in the opposite direction of your gearbox
- In the case the temperature of the working environment is to exceed intervals in between +5° C and + 60° C, Contact the manufacturer to receive special assistance and adapted solution for your environment.
- After starting your gearbox make sure that there is no unusual noise or vibration.
- Obtain an information document on cooling interval period of your products from the manufacturer and take precautions according to the listed intervals.
- In the case you installed optional accessories or external systems, make sure that they are in accordance with the gearbox type and that you respected all the security and conformity norms.

6. CONTROL AND MAINTENANCE

All the maintenance and replacement operations must be carried out by maintenance technicians or authorized sellers. In order to maintain the efficiency and the safety of the gearbox we recommend you to apply all the maintenance advices listed in this manual.



Before starting all operations of maintenance the operator must switch off power to the gearbox and ensure that the machine is out of service. All precaution should also be taken against accidental switch on.

GEARBOXES:

- Check the oil levels. Use the oils and lubricants recommended by the manufacturer.
- Change the oil after 500 hours of initial operation and periodically every 6000 hours of operating the motor.
- During these operations take all measures to avoid contact with oils and greases, respect all the safety precautions listed in this manual.
- Check if the ventilation plug is working or obstructed. If the ventilation plug does not work there is a risk of high pressuring the gearbox and create gas leakage. Periodically remove all dust and residues from the gearbox and the motor casting.
- Check that the gearbox is not generating any noise or vibration. Excessive noise or vibration can indicate the failure of a bearing or damage of the gear train.
- Check the motor connexions. If you are using a brake motor, control the friction surface and adjust the gap if necessary.
- Check if the ventilation stopper is active or not. If the air evacuation hole does not work, the accumulated air in the motor trunk causes pressure and gas leakage from the mats.
- Control the temperature level, make sure that it not rise above normal. If the temperature rise above the tolerated level, immediately stop it and identify the cause of the excess.
- Change the oil after 500 hours of initial operation and periodically every 6000 hours of operating the motor.
- Regularly check all the couplings, control the absence of deformation and corrosion.
- Contact the manufacturer or an authorized seller before operating any special maintenance operations.











7. FREQUENTLY ASKED QUESTIONS

PROBLEM	POSSIBLE CAUSES	SOLUTION
Hardly regular, noises are heard	1. The bearings might be damaged if the noise is like a grinding sound 2. If the like a hitting noise there a change of breakage in the gearing 3. Excesive load	1) Check the oil (See part 6) 2) Contact authorized service 3)Control the adequation of the load with the current capacity of your geared motor.
Irregular noises are heard	There could be foreign substance in the oil	1.Check the oil 2.Stop operating and contact authorized service
<u>Oil is leaking</u> from the motor flange, the oil containers, motors and oil stopper	1.The stopper container or gasket could be damaged 2.The trunk of the motor could be cracked	Contact authorized service
Oil is leaking from the ventilation opening	1.Excess oil might be filled 2.The ventilation opening is not in an appropriate position	1.Check oil levels (See part 8) 2.Check mounting position (See part 8)
The motor is working but the exit pivot or entrance pivot is not rotating	The wedge of the gearing could be scraped of the gears could be completely broken and connection could stop	Contact authorized service



Contact us for further information and inquiries
 I-MAK : imak@imakreduktor.com / export@imakreduktor.com
 +90 216 378 26 36



Lubricant	ISO Viscosity Class	DIN 51517-3	Usage Temperature C°	Firm						
										
Mineral Oil	ISO VG 320	CLP	0.....+100	Mobilgear XMP 320	Degol BG 320	Energol GR-XP320	Omala F320	Alpha SP 320	GEM 1 320 N	Spartan EP 320
	ISO VG 220	CLP	-5.....+100	Mobilgear XMP 220	Degol BG 220	Energol GR-XP220	Omala F220	Alpha SP 220	GEM 1 220 N	Spartan EP 220
	ISO VG 150	CLP	-5.....+100	Mobilgear XMP 150	Degol BG 150	Energol GR-XP150	Omala 150	Alpha SP 150	GEM 1 150 N	Spartan EP 150
	ISO VG 100	CLP	-5.....+100	-	Degol BG 100	Energol GR-XP100	Omala 100	Alpha SP 100	GEM 1 100 N	Spartan EP 100
Synthetic Oil	ISO VG 320	CLP PG	-25.....+140	Gylgoyle 320	Degol GS 320	Enersyn SG-XP320	Tivela S 320	Alphasyn PG 320	Klübersynth GH 6-320	Glycolube 320
	ISO VG 220	CLP PG	-25.....+140	-	Degol GS 220	Enersyn SG-XP220	Tivela S 220	Alphasyn PG 220	Klübersynth GH 6-220	-
	ISO VG 150	CLP PG	-30.....+140	-	Degol GS 150	Enersyn SG-XP150	Tivela S 150	Alphasyn PG 150	Klübersynth GH 6-150	-
	ISO VG 100	CLP PG	-30.....+140	-	-	-	-	-	Klübersynth GH 6-100	-



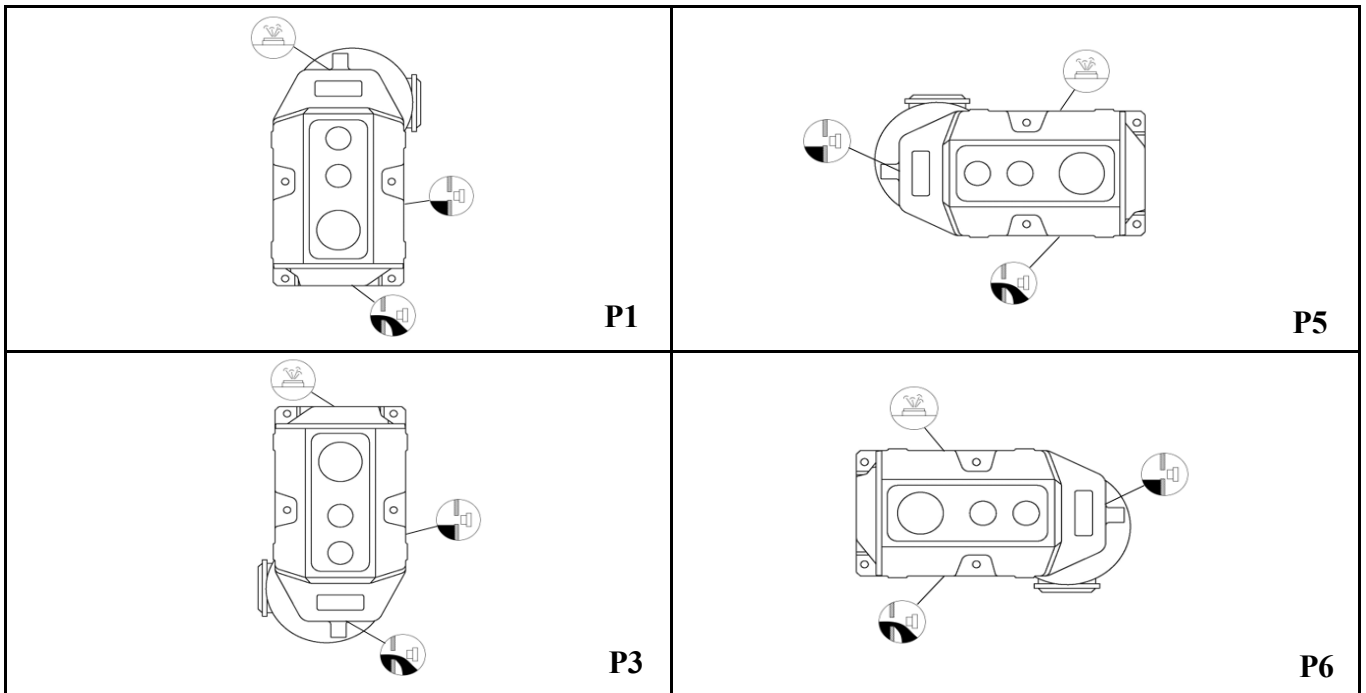

Vent Plug



Oil Level



Drain Plug

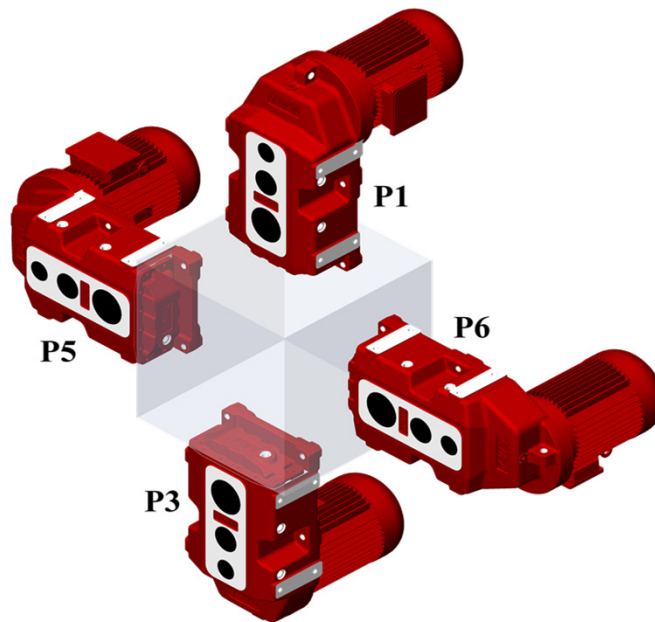

Type	Oil Quantities for Mounting Positions (liter)			
	P1	P3	P5	P6
İRCM 73	3,4	2,7	2,7	2,6
İRCM 83	4,6	4,2	4,4	4,2
İRCM 93	9,6	7,8	9,1	8,3
İRCM 103	18	15,3	18	18,5
İRCM 123	34	21	24	24



General Parts List

TYPE
IRCM - IRCPM - IRC - IRCP } 73-83-93-103-123

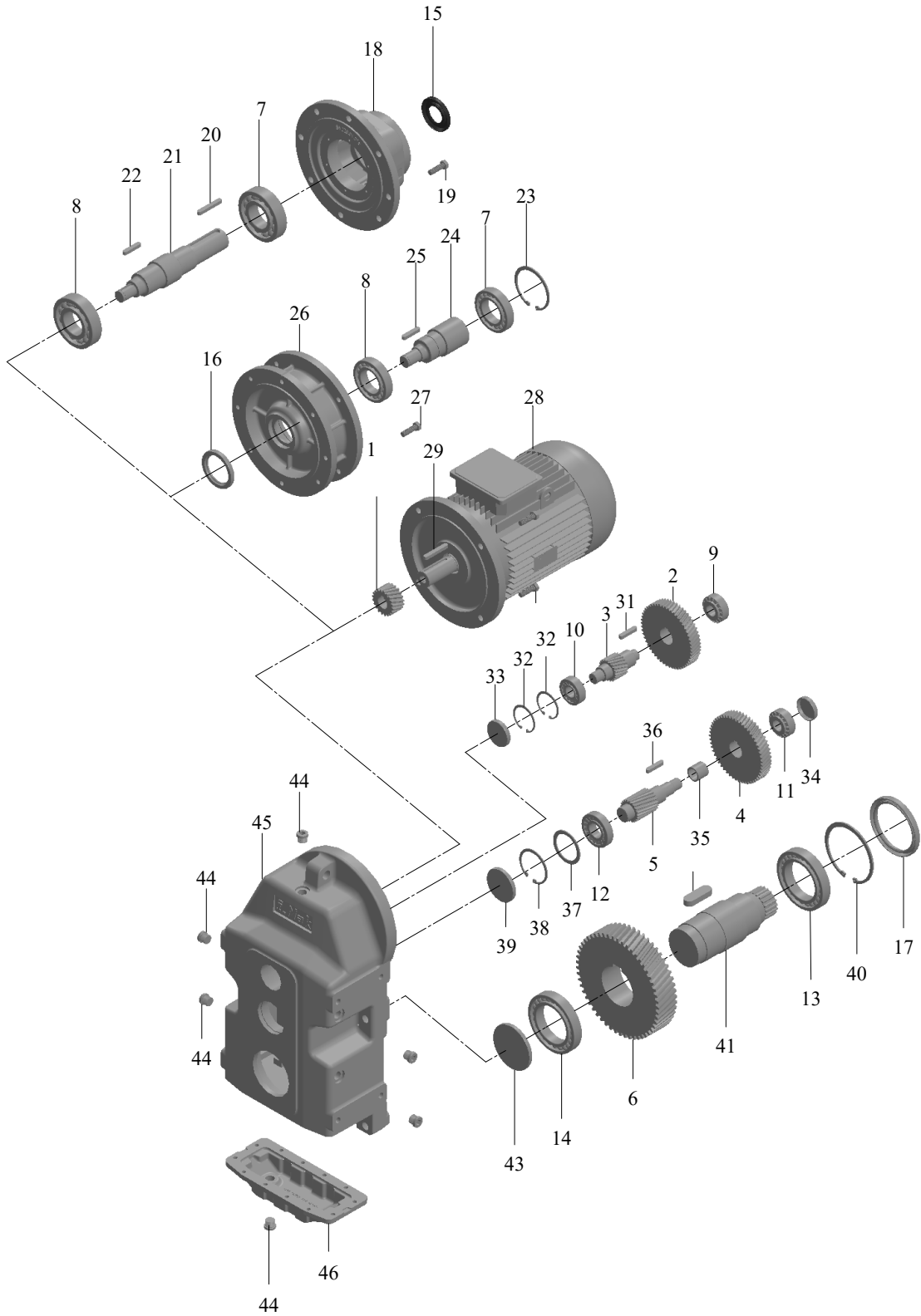

General Parts List

TYPE

IRCM / IRCPM / IRC / IRCP } 73-83-93-103-123

- 1 - Gear Z1
- 2 - Gear Z2
- 3 - Gear Z3
- 4 - Gear Z4
- 5 - Gear Z5
- 6 - Gear Z6
- 7 - Bearing
- 8 - Bearing
- 9 - Bearing
- 10 - Bearing
- 11 - Bearing
- 12 - Bearing
- 13 - Bearing
- 14 - Bearing
- 15 - Seal
- 16 - Seal
- 17 - Seal
- 18 - Gear Case Cover
- 19 - Bolt
- 20 - Key
- 21 - Input Shaft
- 22 - Key
- 23 - Circlip
- 24 - Connection Shaft
- 25 - Key
- 26 - IEC Flange
- 27 - Bolt
- 28 - Electric Motor
- 29 - Key
- 30 - Bolt
- 31 - Key
- 32 - Circlip
- 33 - Locking Cover
- 34 - Locking Cover
- 35 - Spacer
- 36 - Key
- 35 - Washer
- 38 - Circlip
- 39 - Locking Cover
- 40 - Circlip
- 41 - Output Shaft
- 42 - Key
- 43 - Locking Cover
- 44 - Oil Plug
- 45 - Gear Case
- 46 - Cover



WARRANTY CONDITIONS

1. All gearboxes and variators' parts except the engine are warranted for 2(two) year.
2. Conditions in the warranty and user's guide of manufacturer are valid for the Warranty of the Engine.
3. This warranty is valid if there is no direct or indirect intervention to the product by the end user and if it is used accordingly to the user's guide.
4. This warranty does not cover the defects arising from misuse and wrong choices.
5. The time taken for maintenance, repair and replacement made under the warranty shall be added to warranty period. This time starts with the delivery of the product to the service station.
6. Warranty period is valid beginning the invoice date, commissioning date is void.
7. No interference such as mounting, demounting, or maintenance shall be made to the warranted product on the machine or facility it works.
8. Our company does not warrant the parts of other companies which are mounted on our standard product; related company is responsible for the warranty of these products.
9. Warranty conditions cover the parts produced by I-mak Gearbox&Variator Co.; do not cover the customer parts coming with the standard product and damages caused while mounting and demounting these parts.
10. This warranty does not cover the damages that may be occurred during transportation.
11. Consumers have to inform the manufacturer about their questions on maintenance and repair.
12. I-mak Gearbox&Variator Co. is not responsible for the material and moral losses in case of the failure of the product.
13. Our company will supply a free of charge repair in its factory for the product failures under the conditions and period of warranty. Cost of shipment is borne by the user.
14. Only the replaced parts of the products, on which revisions are made, are warranted; warrant period for the spare parts is 6(six) months.



WARRANTY

İ.Mak Gearbox&Variator products and all parts except electrical motor and faulty choices are warranted on condition that they are used accordingly to the user's guide and not maintained, repaired or interfered by any other individuals other than İ.Mak Gearbox&Variator Service Employees, against defects in material, workmanship and manufacturing for 2(two) year.

All costs relating to workmanship and replacement of parts regarding the work performed within the extent of warranty shall be borne by our company.

The time used for repairs to be made within the warranty period shall be added to warranty period.

Power(kW):

Ratio (i):

Type:

Serial Number:

Date:

Manufacturer:

İ-Mak Gearbox & Variator Co.

Factory : Sanayi Caddesi No. 1 Seyhli Pendik – ISTANBUL

Tel: +90 216 378 03 26 Fax: +90 216 378 06 86

Office : Demirkapi Keresteciler Sitesi Rıza Uzun Sokak

No: 21 34030 Topçular – ISTANBUL

Tel: +90 212 567 87 32-33 Fax: +90 212 612 61 17

Authorized Signature/Seal

User Company :



**MANUFACTURER'S DECLARATION IN ACCORDANCE
WITH THE EC MACHINERY DIRECTIVE 98/37/EC**

ANEXIIB

BELGE NO / AY – YIL

DOCUMENT NO. / MONTH – YEAR : İM – 01/11/03

İMALATÇI

MANUFACTURER : İMAK REDÜKTÖR VARYATÖR SAN ve TİC. A.Ş.
DEMİRKAPI KERESTECİLER SİT. RIZA UZUN SOK. NO:21
TOPÇULAR – İSTANBUL – TÜRKİYE

ÜRÜN TANITIMI : HELİSEL ve SONSUZ DİŞLİLİ REDÜKTÖRLER VARYATÖRLER

PRODUCT DESIGNATION : HELICAL and WORM GEARED UNITS VARIABLE SPEED DRIVES

TANIMLANAN ÜRÜNLERİN AŞAĞIDAKİ AVRUPA NORMLARININ TALİMATLARINA UYGUNDUR.
THE DESIGNATED PRODUCTS CONFIRM TO THE PROVISIONS OF THE FOLLOWING EUROPEAN
DIRECTIVES

SAYI / NUMBER : YAYIN TARİHİ :

EN 292 – 1

OCAK 1996

EN 292 – 2

OCAK 1996

UYGULANAN DİREKTİFLER / THE FOLLOWING DIRECTIVES

98/37/AT MAKİNE EMNİYET DİREKTİFİ
98/37/EEC MACHINERY DIRECTIVE

BU TALİMATLARA UYGUNLUKLA İLGİLİ BİLGİLER UYGUNLUK DOSYASINDA BELİRTİLMİŞTİR.
FOR FURTHER INFORMATION ABOUT COMPLIANCE WITH THESE DIRECTIVES SEE TECHNICAL
FILES

CE İŞARETİ UYGULAMA SIRASI / AFFIXING OF THE CE MARKING : 01

TANZİM EDEN / ISSUER : MUSA HALLAÇ

YER – TARİH / PLACE – DATE : İSTANBUL 03.12.03

YETKİLİ İMZA – LEGALLY BINDING SIGNATURE

BU BEYAN, BELİRTİLEN TALİMATLARA UYGUNLUĞU, BELGELER, ÖZELLİKLER İLE İLGİLİ
GARANTİ HAKKI İÇERMEZ. ÜRÜN İLE BİRLİKTE VERİLEN TÜM GÜVENLİK UYARILARI, MONTAJ
VE İŞLETİM TALİMATLARINA UYULMASI GEREKİR. BU BEYAN, DİŞLİ ÜNİTESİ İÇİN GEÇERLİDİR.
MOTORU KAPSAMAZ.

THIS DECLARATION CERTIFIES COMPLIANCE WITH THE INDICATED DIRECTIVES BUT IMPLIENCE
NO WARRANTY OF PROPERTIES ALL SAFETY INSTRUCTIONS SHOWN ON DOCUMENTATION AND
MOUNTING INSTRUCTIONS ETC. SHALL COSERVED. THIS DECLARATION IS VALID ONLY FOR THE
GEAR UNIT PARTS AND DOES NOT COVER THE MOTOR.

KAYIT NO : 113199

