



Cidepa

A GEARS BOXES COMPANY



KM



CFM



CKM



CRM

Versatile geared motor series suiting
your machinery system.



versatile and interchangeable

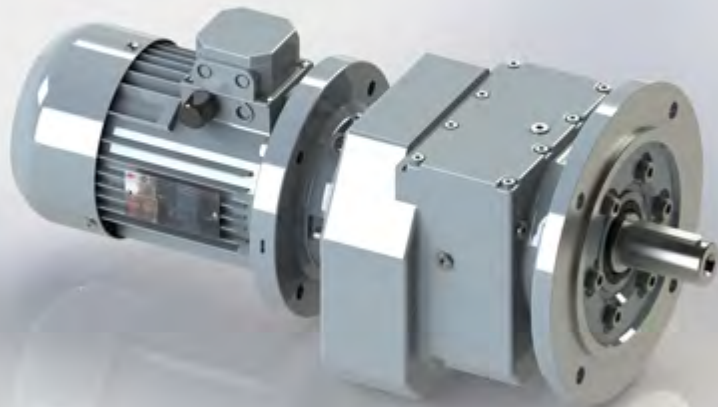

Range CIDEPA-SINCRON

At Cidepa-Sincron we have worked to consolidate our position as a Global Operator in the world of speed reducers. Our goal is to be able to offer a solution for any type of machine or drive required. For this reason, we have a range of gearboxes from small 0.09 hp to large equipment of 1,000 hp.

Worm gear	KM	MF	MQ	SM
Helical in line	CRM	MRH	XR	
Parallel	CFM	ROM		
Helical bevel	CKM	CROM	VCROM	
Shaft Mounted	DPs	DP		
Tandem	RL	CRL		

Our clients support us

AGBAR

ACCIONA

IBERDROLA

REPSOL

ERCROS

ABENGOA

ACS

FCC

OHL

NESTLÉ

DHL

CEMEX

BÜHLER

PORCELANOSA

TORRAS PAPEL

CEPSA

EL POZO

BIMBO

SAINT GOBAIN

MERCADONA

HOJIBLANCA

DURO FELGUERA

TECNICAS REUNIDAS

ENDESA

FMC FORET

ACERINOX

AIR LIQUIDE

INOXPA

COREN

DANONE

COCA-COLA

HEINEKEN

CARBONELL

FAGOR

CARGILL

ARGAL

CAMPOFRÍO

COSENTINO

CROWN CORK

PEPSI

ACEITES LA MASÍA

Our KM series worm gear reducer is built from a cubic-shaped aluminum injection molded body that can be coupled on any of its three sides.

The rigidity of the format is due to the fact that the block itself maintains the tension between the worm and the wheel.

That is because, although its service factor decreases with respect to gray cast iron, we maintain adequate stiffness standards.

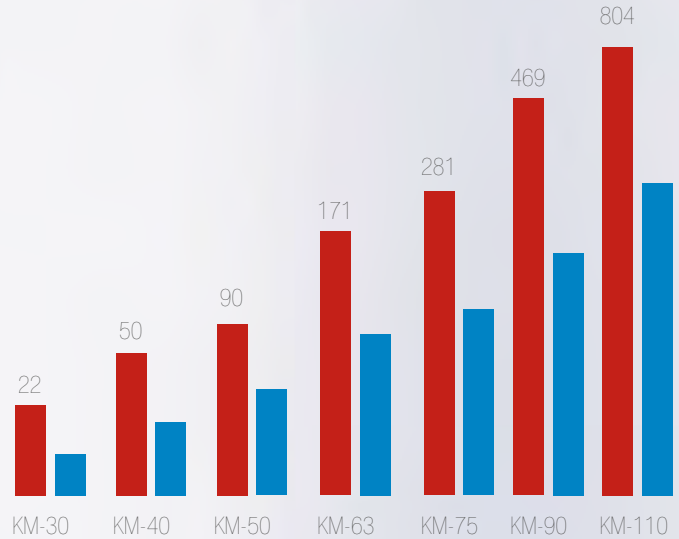

■ CKM RANGE CIDEPA SINCRON (Torque Nm)
■ OTHER MANUFACTURERS



KM

CKM

The CKM and CFM Series are the most complete project we have developed within our orthogonal and parallel products families. Both meet the 4 requirements that we have set as essential in our product philosophy.

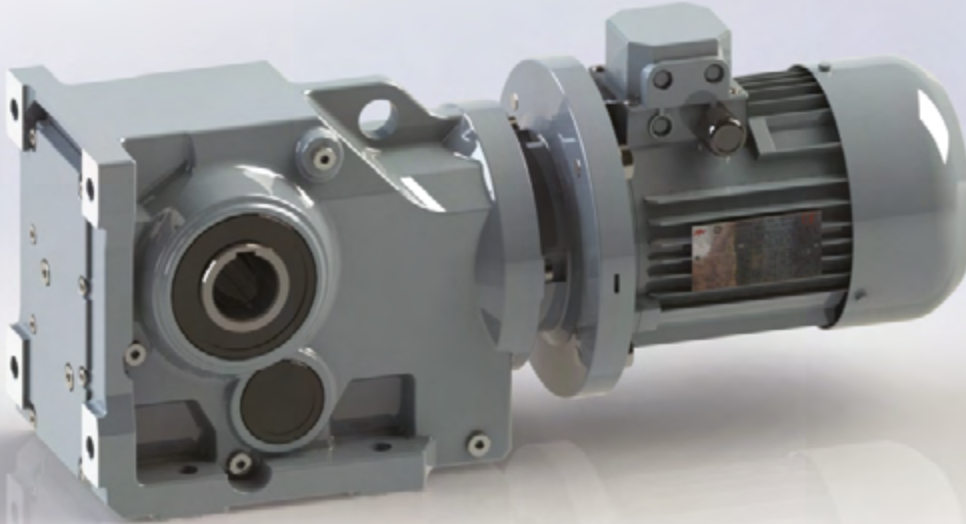
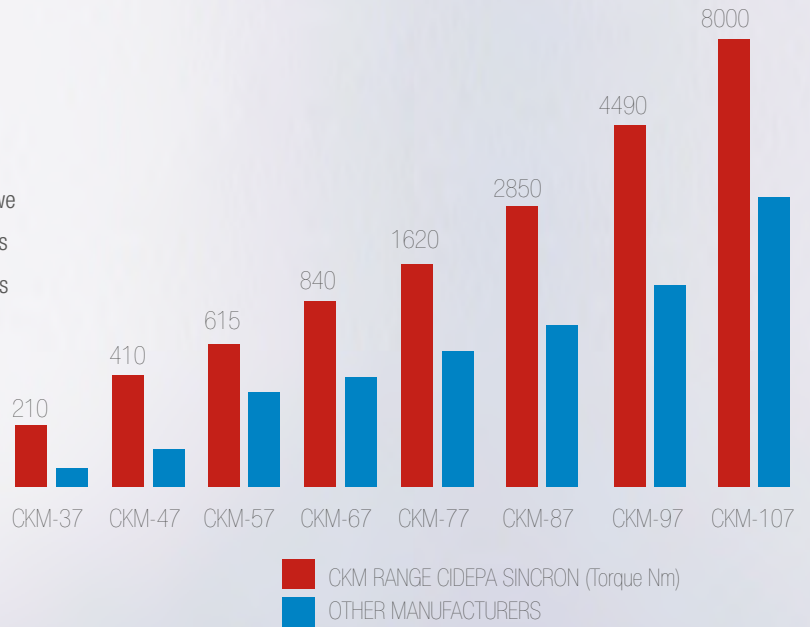

CFM

• **Interchangeability:** In the current world of mechanical transmission any product that is developed must have this attribute. It must be able to reach all markets, all customer segments and those maintenance services that so often need an equivalent replacement.

• **Availability:** Basic condition of any Cidepa-Sincron product. Our customers need to maintain the delivery security that characterizes our brand.

• **Quality:** With this adjective in Cidepa-Sincron we define everything we manufacture. All our products maintain the same criteria of calculation, development, selection of materials and techniques of mechanized of common form.

• **Prices:** We have studied each and every component in its development. Any detail that affects the final product price has been optimized. The processes have been minimized and the number of different pieces has been scrupulously studied. Our suppliers have collaborated in improving the components and the benefits of the same obtaining really good costs.

All these points make us have the best Series of parallel and orthogonal reducers in the market in Price, Quality and Service.

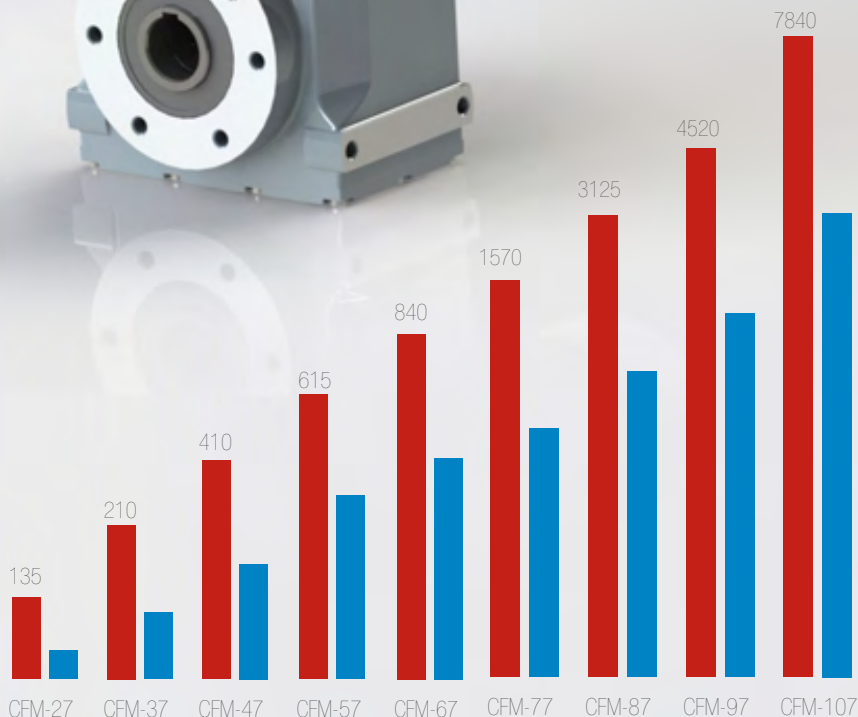
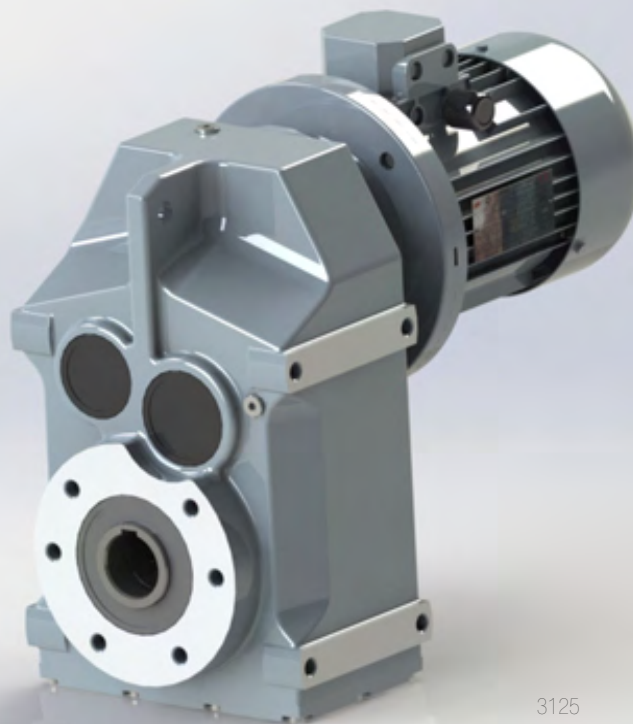

■ CKM RANGE CIDEPA SINCRON (Torque Nm)
■ OTHER MANUFACTURERS



CRM

With the CRM series we close our new project called C (CRM, CFM and CKM) with which we cover the needs of interchangeability, availability, quality, and prices, which we had set when we started its development. And following our philosophy, we keep working to increase this product range, so we will soon launch the size 127 in the three versions.

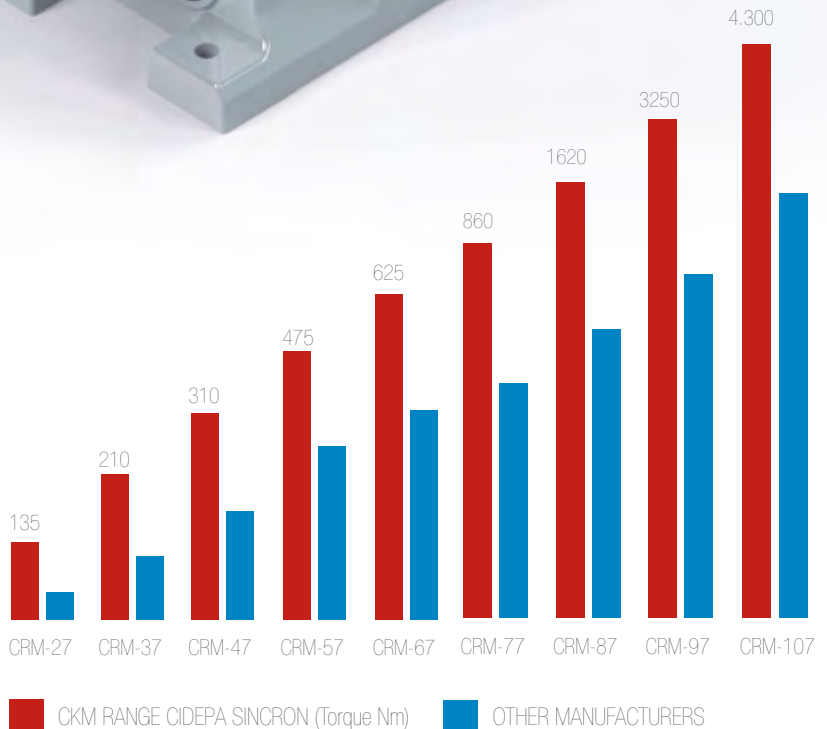



A GEARS BOXES COMPANY

CIDEPA-SINCRÓN S.L.

Industrial Zone Polysol, c/ Polysol 3 nº 15

41500 Alcalá de Guadaíra

Seville • Spain

Phone: +34 95 561 38 21

cidepa@cidepa-sincron.es

www.cidepa-sincron.es



KM



CFM

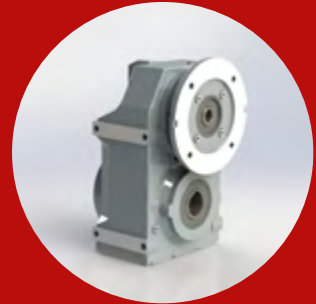

CKM



CRM

